

# 01

furniture with washbasin washbasins  
bathtubs faucets lighting mirrors  
mobiliario con lavabo lavabos bañeras  
grifería iluminación espejos

2015



**Activarse, relajarse, sentirse cómodo...** en el baño nos reencontramos con **nosotros mismos**, a través de una serie de objetos que **trascienden** lo meramente funcional.

**Stimulation, relaxation, comfort...** *the bathroom reintroduces us to ourselves through objects that transcend the merely functional.*

# bath . experiences

## **cosmic** 006 **designawards** 008 **thecreators** 010 **showroom** 012 **thecollections** 014

MOBILIARIO CON LAVABO / FURNITURE WITH WASHBASIN / MEUBLE AVEC  
LAVABO / MÓBIL CON LAVABO / MÓVEL COM LAVATÓRIO / WASCHBECKEN  
MIT UNTERSCHRÄNKE / MEUBLE MET WASTAFEL

014

**BLOCK** 016 **NEW**

**BLOCK EVO** 040 **NEW**

**CONTAINER** 068 **NEW**

**GLOBAL CONTAINER** 084 **NEW**

**FLOW** 102

**MODULAR** 120

LAVABOS / WASHBASINS / LAVABOS / LAVABI / LAVATÓRIOS /  
WASCHBECKEN / WASTAFEL

166

**COMPACT** 168 **NEW**

**FANCY** 184

**MIX** 202 **NEW**

**MODULAR** 216 **NEW**

BAÑERAS / BATHTUBS / BAINOIRES / VASCHE /  
BANHEIRAS / BADEWANNEN / BADKUIPEN

224

**MIX** 226

**UP GRADE** 230

GRIFERÍA / FAUCETS / ROBINETTERIE / RUBINETTI /  
TORNEIRAS / ARMATUREN / KRAAN

236

**CONTROL** 238

**FLOW** 244

ILUMINACIÓN / LIGHTING / LUMINAIRE / ILLUMINAZIONE /  
LUMINÁRIA / BELECHTING / VERLICHTING

248

**LIGHT** 250

ESPEJOS / MIRRORS / MIROIRS / SPECCHI / ESPELHOS /  
SPIEGEL / SPIEGELS

256

**BASIC** 258

**FLOW** 266

**GLOBAL CONTAINER** 272 **NEW**

**LIGHTING** 278

**MIX** 284

**MODULAR** 290

## **salesconditions** 298

CONDICIONES GENERALES DE VENTA / GENERAL SALES CONDITIONS / CONDITIONS  
GÉNÉRALES DE VENTE / CONDIZIONI GENERALI DI VENDITA / CONDIÇÕES GERAIS DE VENDA /  
ALLGEMEINE VERKAUFSBEDINGUNGEN / ALGEMENE VERKOOPVOORWAARDEN

## **technicalspecifications** 300

MATERIALES / MATERIALS / MATÉRIAUX / MATERIALI / MATERIAIS / MATERIAL / MATERIALIEN



entiende el cuarto de baño como un reflejo más de la **personalidad** de cada individuo y su búsqueda del **bienestar** a través del **diseño**. Una de las ofertas más globales y sugestivas existentes en el mercado: accesorios, muebles, lavabos, bañeras, platos de ducha, grifería, iluminación, espejos y complementos.

*conceives the bathroom as an added reflection of a person's **personality** and the search for **wellbeing** through **design**. One of the most global and suggestive offers on the market: accessories, furniture, washbasins, bathtubs, shower trays, fittings, lightings, mirrors and complements.*



# design awards

**2009**

Design Plus colección Flow | *Design Plus Flow collection*

**2007**

Delta plata colección Simplex | *Silver Delta Simplex collection*

Design plus colección Block | *Design Plus Block collection*

**2003**

Príncipe Felipe a la excelencia empresarial | *Principe Felipe for business excellence*

Calidad del diseño en la empresa (BCD-CCB) | *Design quality in the company*

**2002**

Lux Plata campaña de comunicación | *Silver Lux communication campaigns*

**2001**

Lux Oro campaña de comunicación | *Gold Lux communication campaigns*









# showroom

**showroom** es un espacio situado en la sede central de Industrias Cosmic, S.A.U. donde disfrutar de la **experiencia del contacto** con el **producto**. Lavabos, bañeras, duchas, mobiliario, griferías y accesorios...

*Showroom, situated at the central office of Industrias Cosmic, S.A.U., is a place to **experience the contact** with the **product**. Washbasins, bathtubs, shower trays, cabinets, faucets and accessories...*







# furniture with washbasin

<b>block</b>	016	<b>NEW</b>
<b>block evo</b>	040	<b>NEW</b>
<b>container</b>	068	<b>NEW</b>
<b>global container</b>	084	<b>NEW</b>
<b>flow</b>	102	
<b>modular</b>	120	





Esculpir **formas depuradas**.  
Redondear los ángulos. Trazar **líneas  
suaves**. Cosmic ha moldeado una de sus  
colecciones de lavabos más emblemáticas,  
**Block**, resituándola en el tiempo con  
un nuevo material de una **calidad  
excepcional**.

*Sculpt **refined forms**. Soften angles.  
Trace **soft lines**. Cosmic has cast one  
of its most emblematic collections, **Block**,  
relocating it in time using a new material of  
exceptionally **high quality**.*

**block**  
DESIGN BY COSMIC STUDIO

**779 121 403 102 064**  
MUEBLE 2 CAJONES CON LAVABO BIOBASED MATE  
2 DRAWER CABINET WITH BIOBASED MATTE WASHBASIN

**779 001 407 102 064**  
ARMARIO  
CABINET







**779 121 803 110 110**  
MUEBLE 2 CAJONES CON LAVABO BIOBASED MATE  
2 DRAWER CABINET WITH BIOBASED MATTE WASHBASIN  
(100x50x52 CM)







**779 121 803 110 110**  
MUEBLE 2 CAJONES CON LAVABO BIOBASED MATE  
2 DRAWER CABINET WITH BIOBASED MATTE WASHBASIN  
(100x50x52 CM)

**779 001 407 110 110**  
ARMARIO  
CABINET  
(40x26x80 CM)





**779121403108108**  
MUEBLE 2 CAJONES CON LAVABO BIOBASED MATE  
2 DRAWER CABINET WITH BIOBASED MATTE WASHBASIN  
(80x50x52 CM)











**779123015112112**  
MUEBLE 4 CAJONES LAVABO  
BIOBASED MATE SENO IZQUIERDA  
4 DRAWER CABINET & LEFT  
BIOBASED MATTE WASHBASIN SINK  
(160x50x52 CM)



# block

## Muebles / Furniture



**Apertura y cierre amortiguado** con guías de extracción total ocultas **soft & self close**. El interior de los cajones se presenta con contenedores para distribuir los utensilios de forma organizada.

**Self & soft close** with new rail system which can be completely removed. El interior de los cajones se presenta con contenedores para distribuir los utensilios de forma organizada.

**Ouverture et fermeture amortis** des tiroirs avec nouveaux guides d'extraction cachés (**soft & self close**). El interior de los cajones se presenta con contenedores para distribuir los utensilios de forma organizada.

**L'apertura e la chiusura** con le nuove guide d'estrazione sono corredate con il sistema **soft & self close**. El interior de los cajones se presenta con contenedores para distribuir los utensilios de forma organizada.

**Abertura e fecho amortizado** com novas guias de extracção total ocultas **soft & self close**. El interior de los cajones se presenta con contenedores para distribuir los utensilios de forma organizada.

**Schubläden mit neuen Vollauszugsschienen und soft & self close Technik**. El interior de los cajones se presenta con contenedores para distribuir los utensilios de forma organizada.

**Openen en sluiten met schokdemping** met nieuwe, geheel verborgen **Soft & Self close** geleiders die helemaal kunnen worden uitgenomen. El interior de los cajones se presenta con contenedores para distribuir los utensilios de forma organizada.

**Los cajones**, con tirador integrado en el lateral, se extraen totalmente permitiendo un uso muy cómodo.

**The drawers**, with a handle in the side, are completely removable to let the most pleasant use.

**Les tiroirs**, avec la poignée intégrée dans le latéral, se déploient totalement permettant un emploi plus confortable.

**I cassetti**, con le maniglie integrate sui lati, si estraggono totalmente permettendone un uso più comodo.

**As gavetas**, com puxador integrado nas laterais, extraem-se totalmente permitindo um uso mais cómodo.

**Schubläden** mit Vollauszug und seitliche Griffmulden, bequemen Zugriff auf die volle Nutzfläche.

**De laden** met geïntegreerde handgreep aan de zijkant, kunnen helemaal worden uitgenomen, voor meer comfort.



**Pies** opcionales.

**Leg set** (optional).

**Pieds** optionnels.

**Piedi** opzionali.

**Pés** opcionais.

**Optional FüÙe**.

**Poten** optioneel.



**Armario** con estantes en aluminio.  
**Cabinet** with aluminium shelves.  
**Armoire** avec des rayons en aluminium.  
**Armadio** con mensole in alluminio.  
**Armário** com estantes em alumínio.  
**Hängeschränk** mit Aluminium-Böden.  
**Kast** met aluminium planken.



Producto **ambientalmente responsable**: muebles fabricados en España con tableros de madera certificada (PEFC/FSC) conforme la cadena de custodia de productos forestales.

**Eco friendly**: furniture made in Spain with certified wood board (PEFC/FSC) following the chain of custody in forestry.

Produit **eco-responsable** : meubles fabriqués en Espagne avec des panneaux en bois certifié (PEFC/FSC) issu de milieux forestiers gérés durablement.

**I prodotti con responsabilità ambientale**: mobili fabbricati in Spagna con legno certificato (PEFC/FSC) secondo la Catena di Custodia di prodotti forestali.

Produto **ambientalmente responsável**: móveis fabricados em Espanha com placas de madeira certificada (PEFC/FSC) conforme a cadeia de conservação de produtos florestais.

**Umweltgerechtes Produkt**: Möbel Hergestellt in Spanien mit Holzplatten die den (FSC / PEFC -Siegel) haben. Holzprodukt aus zertifizierten und verantwortungsvoll bewirtschafteten Forstbetrieben, durchlaufen von der Waldstraße bis zum Endverbraucher eine lange Kette verschiedener Stufen der Verarbeitung.

**Milieuvriendelijk** product: meubels vervaardigd in Spanje met (PEFC/FSC) gecertificeerde houten platen, conform de bewakingsketen van bosproducten.



**Acabados** lacados de alta gama. Los tonos se mantienen inalterables a lo largo del tiempo.

*Lacquered finishing and high quality laminate. Colours unalterable.*

**Finitions** laquées et laminées haut gamme. Les couleurs restent inaltérables au fil du temps.

*Finiture* laccate e laminati d'alta gamma. Le tonalità di colore rimangono inalterate nel tempo.

**Acabamentos** lacados e laminados de alta gama. Os tons mantêm-se inalteráveis ao longo do tempo.

*Hochwertige laminierte und lackierte Oberflächen. Die Farben bleiben im Laufe der Zeit unverändert.*

Gelakte **afwerking** en hoogwaardig laminaat. De kleuren blijven door de jaren heen onveranderd.

Toda la gama Block ha superado con éxito exigentes tests de durabilidad y resistencia a usos extremos (cargas estáticas o test de impacto), para asegurar una **larga vida** al producto.

*Block has successfully passed the high demanding tests of long last durability and resistance to extreme uses (static charge or impact testing) to assure **long last durability** of the product.*

Toute la gamme Block a réussi avec succès aux exigences des tests de durabilité et résistance à usages extrêmes (charges statiques ou test d'impact) afin d'assurer une **longue vie** de ce produit.

*Tutta la gamma Block ha superato le prove di durata e resistenza all'uso estremo (carichi statici o prova d'impatto), per garantire una **lunga durata** del prodotto.*

Toda a gama Block superou com êxito exigentes testes de durabilidade e resistência a usos extremos (cargas estáticas ou testes de impacto), para assegurar uma **longa vida** ao produto.

*Die Serie Block wurde strengen Tests für Haltbarkeit und Beständigkeit gegen extreme Einsätze (statische Lasten oder Schlagprüfung) unterzogen und diese erfolgreich bestanden, um somit eine **lange Lebensdauer** gewährleisten zu können.*

De hele Block-reeks heeft de duurzaamheids- en resistentieproeven bij extreem gebruik (statische lading of schokproef) succesvol doorstaan, zodat een **lange levensduur** van het product gegarandeerd is.



# block

## Lavabos / Washbasin



### Solid Surface Biobased Washbasins

Lavabos de Cristalplant® Biobased: material compuesto, tecnológicamente avanzado y único, formado por un 50% de minerales naturales (trihidrato de aluminio -ATH- derivado de la bauxita) y un 50% de biorresinas de poliéster de gran pureza; se trata, por lo tanto, de un material **inerte, hipoalérgico y no tóxico.**

### Solid Surface Biobased Washbasins

*Cristalplant® Biobased Washbasins: unique compound material, technologically advanced, made up of 50% natural minerals (aluminium trihydrate -ATH- derived from bauxite) and 50% high-purity polyester bioresins. An **inert, hypoallergenic, non-toxic** material.*

### Solid Surface Biobased Washbasins

Lavabos de Cristalplant® Biobased : matériau composite, technologiquement de pointe et unique, composé à 50 % de minéraux naturels (hydroxyde d'aluminium - ATH - dérivé de la bauxite) et à 50 % de résines bio polyester d'une grande pureté ; il s'agit par conséquent d'un matériau **inerte, hypoallergique et non toxique.**

### Solid Surface Biobased Washbasins

*Lavabi Cristalplant® Biobased: materiale composto, tecnologicamente avanzato e unico, formato per un 50% da minerali naturali (tridrato di alluminio - ATH - derivato dalla bauxite) e per l'altro 50% da biosine di poliesteri di elevata purezza. Si tratta quindi di un materiale **inerte, ipoallergenico e atossico.***

### Solid Surface Biobased Washbasins

Lavatórios de Cristalplant® Biobased: material composto, tecnológicamente avançado e único, formado por 50% de minerais naturais (trihidrato de alumínio - ATH - derivado da bauxite) e 50% de biorresinas de poliéster de elevada pureza. Trata-se portanto de um material **inerte, hipoalérgico e não tóxico.**

### Solid Surface Biobased Washbasins

*Washbecken aus Cristalplant® Biobased, einem technologisch fortschrittlichen und einzigartigen Verbundstoff, der zu 50 % aus natürlichen Mineralien (Aluminiumtrihydrat -ATH-, einem Bauxit-Derivat) und zu 50 % aus hochreinen Polyester-Bioharz besteht. Es handelt sich daher um ein **inertes, hypoallergenes und ungiftiges** Material.*

### Solid Surface Biobased Washbasins

Wastafels van Cristalplant® Biobased: technisch geavanceerd en uniek composietmateriaal, voor 50% bestaand uit natuurlijke mineralen (aluminiumhydroxide -ATH- een derivaat van bauxiet) en voor 50% uit zeer zuiver polyester bioharsen. Het is daarom een **inert, hypoallergene en niet giftig** materiaal.

**Resinas de origen vegetal:** es el primer solid surface eco sostenible que deriva de materias primas resinosas de origen vegetal mezcladas con minerales inertes y naturales de extrema pureza. El 30% de la resina, anteriormente de origen fósil, ha sido substituida por poliésteres de origen vegetal procedentes de cultivos certificados.

**Plant resins:** *this is the first ecologically sustainable solid surface derived from plant resins mixed with highly pure natural minerals. Some 30% of the resin component, formerly of fossil origin, has been replaced with polyesters of plant origin from certified growers.*

### Résines d'origine végétale :

il s'agit de la première Solid Surface éco durable qui provient de matières premières résineuses d'origine végétale mélangées à des minéraux naturels de grande pureté. 30 % de la résine utilisée auparavant, d'origine fossile, a été remplacée par des polyesters d'origine végétale provenant de cultures certifiées.

### Resine di origine vegetale: è

*il primo solid surface ecosostenibile, derivato da materie prime resinose di origine vegetale mescolate con minerali naturali di estrema purezza. Il 30% di resina, in precedenza di origine fossile, è stato sostituito da poliesteri di origine vegetale provenienti da coltivazioni certificate.*

### Resinas de origem vegetal:

trata-se do primeiro material solid surface (superfície sólida) ecossustentável derivado de matérias-primas resinosas de origem vegetal misturadas com minerais naturais de extrema pureza. Cerca de 30% da resina, anteriormente de origem fósil, foi substituída por poliésteres de origem vegetal provenientes de culturas certificadas.

### Pflanzliche Harze: Cristalplant®

*Biobased ist der erste nachhaltige Mineralwerkstoff, der aus harzigen pflanzlichen Rohstoffen, die mit hochreinen natürlichen Mineralien vermischt werden, gewonnen wird. 30 % des ursprünglich fossilen Harzes wurde durch pflanzliche Polyester ersetzt, die aus kontrolliertem Anbau stammen.*

### Harsen van plantaardige herkomst:

dit is het eerste milieuvriendelijke solid surface dat gemaakt is uit harsachtige materialen van plantaardige oorsprong, gemengd met natuurlijke en zeer zuivere mineralen. 30% van de hars, vroeger van fossiele oorsprong, is vervangen door polyester van plantaardige herkomst, afkomstig van gecertificeerde teelt.





**Sin OGM:** es un material idóneo para obtener puntuación VOC (Compuestos Orgánicos Volátiles) y BIO-BASED para el certificado de eco-sostenibilidad "Leadership in Energy and Environmental Design". El material obtuvo el certificado que confirma que las resinas derivan de almidones vegetales y maíz sin OGM (organismos genéticamente modificados); en el material, dichas resinas superan incluso el 12%, cuando el requisito mínimo es normalmente del 5%.

**Non-GMO:** VOC (Volatile organic compounds) and BIO-BASED points awarded for the eco-sustainability certificate "Leadership in Energy and Environmental Design". This material has been certified as containing resins derived from vegetable starches and non-GMO corn. While the minimum requirement is 5%, these resins reach 12% in our product.

**Sans OGM :** matériau idéal pour obtenir une notation COV (composés organiques volatils) et BIO-BASED pour la certification d'éco durabilité LEED « Leadership in Energy and Environmental Design ». Le matériau a obtenu la certification qui confirme que les résines sont issues d'amidons végétaux et de maïs sans OGM (organisme génétiquement modifié). Ces résines dépassent même 12 % du matériau, alors que l'exigence minimale est de 5 %.

**Senza OGM:** materiale idoneo per l'ottenimento del punteggio VOC (composti organici volatili) e BIO-BASED per il certificato "Leadership in Energy and Environmental Design". Il materiale ha ottenuto la certificazione che conferma la derivazione delle resine da amidi vegetali e mais senza OGM (organismi geneticamente modificati). Tali resine sono superiori al 12%, mentre il requisito minimo è del 5%.

**Sem OGM:** é um material idóneo para conseguir a pontuação VOC (Compostos Orgânicos Voláteis) e BIOBASED para obter a certificação de ecossustentabilidade "Leadership in Energy and Environmental Design". O material obteve a certificação que confirma que as resinas têm origem em amidos vegetais e milho sem OGM (organismos geneticamente modificados). As referidas resinas representam mais de 12%, quando o requisito mínimo é de 5%.

**OMG-frei:** *Cristalplant® Biobased ist das ideale Material, welches bei VOC (Flüchtige organische Verbindungen) und Bio-Based höher bewertet wurde und somit das Zertifikat für Öko-Nachhaltigkeit "Leadership in Energy and Environmental Design" bekommen hat. Dieses Material erhielt diese Zertifizierung, welche bestätigt, dass die Harze aus Stärke von Pflanzen und Mais ohne GVO (Gentechnisch veränderter Organismus), abstammen. Der Gehalt an dieser Art von Harzen übersteigt in dem Material sogar 12 %, obwohl die Mindestvoraussetzung normalerweise bei 5 % liegt.*

**Zonder GGO:** een ideaal materiaal voor de VOC-klasse (Vluchtige Organische Stoffen) en BIO-BASED voor het verkrijgen van het "Leadership in Energy and Environmental Design" duurzaamheidscertificaat. Het materiaal heeft het certificaat ontvangen waarmee erkend wordt dat de harsen afkomstig zijn van plantaardig zetmeel en maïs, zonder GGO (Genetisch gewijzigde organismen). Die harsen maken meer dan 12% uit, terwijl de minimumeis 5% bedraagt.

### Recyclable 100%:

puede ser reemplazado y utilizado al final de la vida como inerte.

### 100% recyclable:

100% of the material can be recovered.

### Recyclable à 100 % :

il peut être totalement récupéré.

### Riciclabile al 100%:

può essere recuperato totalmente.

### 100% reciclável:

pode ser totalmente recuperado.

### Zu 100 % recycelbar:

Das Material kann vollständig wiederverwertet werden.

### 100% recycleerbaar:

het kan helemaal worden hergebruikt.



**Menos CO<sub>2</sub>:** composición muy ligera, ha reducido su peso específico en un 30%, produciendo, por tanto, menos CO<sub>2</sub> con respecto a productos similares disponibles actualmente en el mercado, además de facilitar su manipulación e instalación.

**Less CO<sub>2</sub>:** 30% lighter which not only allows for easier manipulation and installation but produces less CO<sub>2</sub> than other similar products.

**Moins de CO<sub>2</sub> :** composition plus légère de 30 %, ce qui facilite sa manipulation et son installation tout en produisant moins de CO<sub>2</sub> que d'autres produits similaires du marché.

**Meno CO<sub>2</sub>:** *composizione più leggera del 30% che, oltre a facilitare la manipolazione e l'installazione, consente di produrre meno CO<sub>2</sub> rispetto ai prodotti simili presenti sul mercato.*

**Com menos CO<sub>2</sub>:** com uma composição 30% mais leve, que, para além de facilitar a sua manipulação e instalação, produz menos CO<sub>2</sub> que os produtos similares existentes no mercado.

**Geringerer CO<sub>2</sub>- Ausstoß:** *Leichteres Material, da sein Eigengewicht um 30 % reduziert wurde, und produziert, im Vergleich zu ähnlichen, aktuell auf dem Markt erhältlichen Produkten, demnach weniger CO<sub>2</sub> und vereinfacht zudem das Handling und die Installation.*

**Minder CO<sub>2</sub>:** 30% lichtere samenstelling, waardoor het, behalve gemakkelijker te hanteren en te installeren, minder CO<sub>2</sub> produceert dan gelijksoortige producten op de markt.

# block

## Lavabos / Washbasin



### Alta resistencia al fuego:

es prácticamente ignífugo, con certificado de resistencia al fuego Clase 1.

### Highly fire resistant:

*the material is practically fireproof, with Class 1 fire resistance rating*

### Haute résistance au feu :

il est pratiquement ignifuge et a obtenu une certification de résistance au feu de Classe 1.

### Alta resistenza al fuoco:

*praticamente ignifugo, dotato del certificato di resistenza al fuoco Classe 1.*

### Alta resistência ao fogo:

é praticamente à prova de fogo, com a certificação de Classe 1 de resistência ao fogo.

### Hohe Feuerbeständigkeit:

*Das Material ist praktisch feuerfest, mit einem Zertifikat der Feuerwiderstandsklasse 1.*

### Zeer vuurbestendig:

is praktisch onbrandbaar, met een certificaat van Brandweerstandsklasse 1.

### Duradero y recuperable:

material que puede recuperar completamente su aspecto original utilizando simplemente detergentes y estropajos abrasivos para eliminar incluso las quemaduras de cigarrillo. Sus propiedades de duración y capacidad de recuperación lo convierten en un material eco-compatible.

### Durable and recoverable:

*this material regains its original appearance using soapy water and a scrubber which will eliminate even cigarette burns. The durable and recoverable nature make this is an eco-compatible material.*

### Durable et récupérable :

matériau qui peut récupérer entièrement son aspect original en utilisant simplement de l'eau savonneuse et des éponges abrasives pour éliminer jusqu'aux brûlures de cigarette. Ces caractéristiques de durabilité et de restauration en font un matériau éco compatible.

### Durevole e recuperabile:

*materiale in grado di recuperare completamente l'aspetto originario con il semplice uso di acqua saponata e pagliette abrasive per eliminare anche le bruciature di sigarette. Le proprietà di durevolezza e capacità di recupero che lo contraddistinguono lo rendono un materiale ecocompatibile.*

### Duradouro e recuperável:

trata-se de um material que pode recuperar completamente o seu aspeto original utilizando simplesmente água e sabão e um esfregão abrasivo para eliminar inclusivamente as queimaduras de cigarros. As suas propriedades de durabilidade e capacidade de recuperação tornam-no um material ecocompatível.

### Langlebig und wiederherstellbar:

*Das Material kann mit Seifenwasser und einem Scheuerschwamm vollständig in seinen ursprünglichen Zustand zurückgebracht werden, und selbst Brandmale von Zigaretten verschwinden auf diese Weise. Aufgrund seiner Langlebigkeit und Wiederherstellbarkeit ist das Material sehr umweltverträglich.*

### Duurzaam en herstelbaar:

materiaal dat zijn originele aspect volledig terugkrijgt, door het slechts met zeepsop en een schuursponsje te behandelen, waarmee zelfs brandplekken van sigaretten kunnen worden verwijderd. De duurzame eigenschappen en het herstellend vermogen maken het tot een milieuvriendelijk materiaal.



### Óptima resistencia a los rayos ultravioletas:

es compacto, no poroso, higiénico, resistente y agradable al tacto gracias a su acabado aterciopelado, similar al de la piedra natural.

### Optimum ultraviolet resistance:

*compact, non-porous, hygienic, resistant and pleasant to the touch thanks to the velvety finish, similar to natural stone.*

### Résistance optimale aux rayons ultraviolets :

il est compact, non poreux, hygiénique, résistant et agréable au toucher grâce à sa finition veloutée, similaire à de la pierre naturelle.

### Ottima resistenza ai raggi ultravioletti:

*compatto, non poroso, igienico, resistente e piacevole al tatto grazie alla finitura vellutata che lo rende simile alla pietra naturale.*

### Ótima resistência a radiação ultravioleta:

é um material compacto, não poroso, higiénico, resistente e agradável ao tato graças ao seu acabamento aveludado, idêntico à pedra natural.

### Sehr gute UV-Beständigkeit:

*Das Material ist kompakt, nicht porös, hygienisch, langlebig und angenehm im Griff dank seiner samtigen, dem Naturstein ähnlichen Oberfläche.*

### Optimaal bestand tegen UV-straling:

compact, niet poreus, hygiënisch, bestendig; voelt aangenaam aan dankzij de fluweelachtige afwerking, lijkend op die van natuursteen.



Al presionar la tapa abrimos o cerramos la válvula automática **oculta** click-clack.

*The hidden click-clack drain valve can be easily open and close by pressing the cover.*

Système d'ouverture/fermeture de la **bonde cachée** clic-clack par légère pression sur le couvercle de la bonde.

*Premendo sulla parte superiore, apriamo e chiudiamo la **piletta automatica** click-clack.*

Ao presionar a tampa abrimos ou fechamos a válvula automática **oculta** clic-clack.

*Beim Drücken auf dem Ablaufdeckel wird das darunter sitzende **Ablaufventil** Klick-Klack geöffnet oder geschlossen.*

Door erop te drukken kunt u de automatische **verborgen** click-clack **afvoerplug** openen of sluiten.



# block



CODIFICACIÓN / CODE / CODIFICATION / CODICE / CODIFICAÇÃO / KODIFIZIERUNG / CODIFICATIE

779 121 003 AAA BBB

COLECCIÓN / COLLECTION / COLLECCIÓN / COLLEZIONE / COLEÇÃO / KOLLEKTION / COLLECTIE

MODELO / TYPE / MODÈLE / MODEL / MODELO / MODELL / MODEL

COLOR CUERPO / STRUCTURE COLOUR / COLORIS CORPS / COLORE DEL CORPO / COR CORPO / GEHÄUSEFARBE / ROMP KLEUR

COLOR PUERTA / DOOR COLOUR / COLORIS PORTES / COLORE DELLE PORTE / COR PORTA / TÜRENFARBE / DEUREN KLEUR

## AAA / BBB

### LACADO MATE / MATTE LACQUERED / LAQUÉ MAT / LACCATO SATINATO / LACADO MATE / LACKIERT MATT / MAT LAK

COLOR CUERPO Y FRONTAL  
STRUCTURE AND FRONT COLOUR  
COLORIS CORPS ET FAÇADES  
COLORE DEL CORPO E DEL FRONTALE  
COLOR DE CORPO E FRONTAL  
GEHÄUSE-UND FRONTFARBE  
ROMP EN VOORZIJDE KLEUR



**102**  
BLANCO MATE  
MATTE WHITE  
BLANC MAT  
BIANCO SATINATO  
BRANCO MATE  
WEISS MATT  
MAT WIT



**104**  
GRIS CLARO MATE  
MATTE LIGHT GREY  
GRIS CLAIR MAT  
GRIGIO CHIARO SATINATO  
CINZENTO CLARO MATE  
HELLGRAU MATT  
MAT LICHTGRIJS



**110**  
CREMA LIGHT MATE  
MATTE LIGHT CREAM  
CRÈME LIGHT MAT  
LIGHT CREMA SATINATO  
CREME LIGHT MATE  
CREME LIGHT MATT  
MAT LICHTE ROOM



**140**  
GRIS OLIVA MATE  
MATTE OLIVE GREY  
GRIS OLIVE MAT  
GRIGIO OLIVA SATINATO  
CINZENTO AZEITONA MATE  
OLIVEGRAU MATT  
MAT OLIJF GRIJS



**112**  
VISION MATE  
MATTE MINK  
VISION MAT  
VISIONE SATINATO  
VISION MATE  
NERZ MATT  
MAT NERTS



**106**  
GRIS AMATISTA MATE  
MATTE AMETHYST GREY  
GRIS AMÉTHYSTE MAT  
GRIGIO AMETISTA SATINATO  
CINZENTO AMETISTA MATE  
AMETHYSTGRAU MATT  
MAT AMETHIST GRIJS



**114**  
CHOCOLATE MATE  
MATTE CHOCOLATE  
CHOCOLAT MAT  
CIOCCOLATA SATINATO  
CHOCOLATE MATE  
SCHOKOLADEN MATT  
MAT CHOCOLADE



**108**  
NEGRO MATE  
MATTE BLACK  
NOIR MAT  
NERO SATINATO  
PRETO MATE  
SCHWARZ MATT  
MAT ZWART



**116**  
VERDE MATE  
MATTE GREEN  
VERT MAT  
VERDE SATINATO  
VERDE MATE  
GRÜN MATT  
MAT GROEN



**126**  
AZUL MATE  
MATTE BLUE  
BLEU MAT  
BLU SATINATO  
AZUL MATE  
BLAU MATT  
MAT BLAUW



**124**  
BERENJENA MATE  
MATTE AUBERGINE  
AUBERGINE MAT  
MELANZANA SATINATO  
BERINJELA MATE  
AUBERGINE MATT  
MAT AUBERGINE



**122**  
ROSA MATE  
MATTE PINK  
ROSE MAT  
ROSA SATINATO  
ROSA MATE  
ROSA MATT  
MAT ROZE



**120**  
RUBI MATE  
MATTE RUBY  
RUBIS MAT  
RUBINO SATINATO  
RUBY MATE  
RUBIN MATT  
MAT ROBJUN



**118**  
NARANJA MATE  
MATTE ORANGE  
ORANGE MAT  
ARANCIONE SATINATO  
LARANJA MATE  
ORANGE MATT  
MAT ORANJE



**128**  
GRIS METALIZADO MATE  
MATTE METALLIC GREY  
GRIS MÉTALLISÉ MAT  
GRIGIO METAL SATINATO  
CINZENTO METAL MATE  
GRAU METALLIC MATT  
MAT METALLIC GRIJS

## BBB

### LACADO BRILLO / GLOSSY LACQUERED / LAQUÉ BRILLANT / LACCATO LUCIDO / LACADO BRILHO / LACKIERT GLANZEND / GLANZEND LAK

COLOR FRONTAL  
FRONT COLOUR  
COLORIS FAÇADES  
COLORE DEL FRONTALE  
COLOR DE FRONTAL  
FRONTFARBE  
VOORZIJDE KLEUR



**064**  
BLANCO BRILLO  
GLOSSY WHITE  
BLANC BRILLANT  
BIANCO LUCIDO  
BRANCO BRILHO  
WEISS GLANZEND  
GLANZEND WIT



**103**  
GRIS CLARO BRILLO  
GLOSSY LIGHT GREY  
GRIS CLAIR BRILLANT  
GRIGIO CHIARO LUCIDO  
CINZENTO CLARO BRILHO  
HELLGRAU GLANZEND  
GLANZEND LICHTGRIJS



**109**  
CREMA LIGHT BRILLO  
GLOSSY LIGHT CREAM  
CRÈME LIGHT BRILLANT  
LIGHT CREMA LUCIDO  
CREME LIGHT BRILHO  
CREME LIGHT GLANZEND  
GLANZEND LICHTE ROOM



**139**  
GRIS OLIVA BRILLO  
GLOSSY OLIVE GREY  
GRIS OLIVE BRILLANT  
GRIGIO OLIVA LUCIDO  
CINZENTO AZEITONA BRILHO  
OLIVEGRAU GLANZEND  
GLANZEND OLIJF GRIJS



**111**  
VISION BRILLO  
GLOSSY MINK  
VISION BRILLANT  
VISIONE LUCIDO  
VISION BRILHO  
NERZ GLANZEND  
GLANZEND NERTS



**105**  
GRIS AMATISTA BRILLO  
GLOSSY AMETHYST GREY  
GRIS AMÉTHYSTE BRILLANT  
GRIGIO AMETISTA LUCIDO  
CINZENTO AMETISTA BRILHO  
AMETHYSTGRAU GLANZEND  
GLANZEND AMETHIST GRIJS



**113**  
CHOCOLATE BRILLO  
GLOSSY CHOCOLATE  
CHOCOLAT BRILLANT  
CIOCCOLATA LUCIDO  
CHOCOLATE BRILHO  
SCHOKOLADEN GLANZEND  
GLANZEND CHOCOLADE



**034**  
NEGRO BRILLO  
GLOSSY BLACK  
NOIR BRILLANT  
NERO LUCIDO  
PRETO BRILHO  
SCHWARZ GLANZEND  
GLANZEND ZWART



**115**  
VERDE BRILLO  
GLOSSY GREEN  
VERT BRILLANT  
VERDE LUCIDO  
VERDE BRILHO  
GRÜN GLANZEND  
GLANZEND GROEN



**125**  
AZUL BRILLO  
GLOSSY BLUE  
BLEU BRILLANT  
BLU LUCIDO  
AZUL BRILHO  
BLAU GLANZEND  
GLANZEND BLAUW



**123**  
BERENJENA BRILLO  
GLOSSY AUBERGINE  
AUBERGINE BRILLANT  
MELANZANA LUCIDO  
BERINJELA BRILHO  
AUBERGINE GLANZEND  
GLANZEND AUBERGINE



**121**  
ROSA BRILLO  
GLOSSY PINK  
ROSE BRILLANT  
ROSA LUCIDO  
ROSA BRILHO  
ROSA GLANZEND  
GLANZEND ROZE



**119**  
RUBI BRILLO  
GLOSSY RUBY  
RUBIS BRILLANT  
RUBINO LUCIDO  
RUBY BRILHO  
RUBIN GLANZEND  
GLANZEND ROBJUN



**117**  
NARANJA BRILLO  
GLOSSY ORANGE  
ORANGE BRILLANT  
ARANCIONE LUCIDO  
LARANJA BRILHO  
ORANGE GLANZEND  
GLANZEND ORANJE



**127**  
GRIS METALIZADO BRILLO  
GLOSSY METALLIC GREY  
GRIS MÉTALLISÉ BRILLANT  
GRIGIO METAL LUCIDO  
CINZENTO METAL BRILHO  
GRAU METALLIC GLANZEND  
GLANZEND METALLIC GRIJS

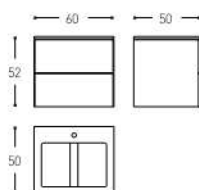

INCH 23.62x19.69x20.47

- MUEBLE 2 CAJONES CON LAVABO MATE
- 2 DRAWER CABINET WITH MATTE WASHBASIN
- MEUBLE 2 TIROIRS AVEC LAVABO MAT
- MOBILETTO 2 CASSETTI CON LAVABO OPACO
- MÓVEL DE 2 GAVETAS COM LAVATÓRIO MATE
- SCHRANK 2 SCHUBLADEN WASCHBECKEN MATT
- MEUBEL 2 LADEN MET WASTAFEL MAT

**NEW 779 121 003 AAA BBB\***

Frontal mate / Matte front part / Façade mat / Frontalino satinato / Frontal mate / Schubladenfront matt / Mat voorzijde

Frontal brillo / Glossy front part / Façade brillant / Frontalino lucido / Frontal brilho / Schubladenfront glänzend / Glanzend voorzijde

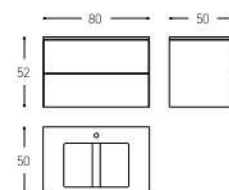

INCH 31.5x19.69x20.47

- MUEBLE 2 CAJONES CON LAVABO MATE
- 2 DRAWER CABINET WITH MATTE WASHBASIN
- MEUBLE 2 TIROIRS AVEC LAVABO MAT
- MOBILETTO 2 CASSETTI CON LAVABO OPACO
- MÓVEL DE 2 GAVETAS COM LAVATÓRIO MATE
- SCHRANK 2 SCHUBLADEN WASCHBECKEN MATT
- MEUBEL 2 LADEN MET WASTAFEL MAT

**NEW 779 121 403 AAA BBB\***

Frontal mate / Matte front part / Façade mat / Frontalino satinato / Frontal mate / Schubladenfront matt / Mat voorzijde

Frontal brillo / Glossy front part / Façade brillant / Frontalino lucido / Frontal brilho / Schubladenfront glänzend / Glanzend voorzijde

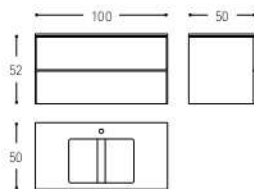

INCH 39.37x19.69x20.47

- MUEBLE 2 CAJONES CON LAVABO MATE
- 2 DRAWER CABINET WITH MATTE WASHBASIN
- MEUBLE 2 TIROIRS AVEC LAVABO MAT
- MOBILETTO 2 CASSETTI CON LAVABO OPACO
- MÓVEL DE 2 GAVETAS COM LAVATÓRIO MATE
- SCHRANK 2 SCHUBLADEN WASCHBECKEN MATT
- MEUBEL 2 LADEN MET WASTAFEL MAT

**NEW 779 121 803 AAA BBB\***

Frontal mate / Matte front part / Façade mat / Frontalino satinato / Frontal mate / Schubladenfront matt / Mat voorzijde

Frontal brillo / Glossy front part / Façade brillant / Frontalino lucido / Frontal brilho / Schubladenfront glänzend / Glanzend voorzijde

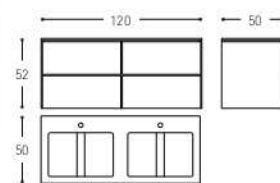

INCH 47.24x19.69x20.47

- MUEBLE 4 CAJONES CON LAVABO MATE 2 SENOS
- 4 DRAWER CABINET WITH 2 SINK MATTE WASHBASIN
- MEUBLE 4 TIROIRS AVEC LAVABO MAT 2 VASQUES
- MOBILETTO 4 CASSETTI CON LAVABO OPACO 2 SENI
- MÓVEL DE 4 GAVETAS COM LAVATÓRIO MATE 2 PIAS
- SCHRANK 4 SCHUBLADEN 2 WASCHBECKEN MATT
- MEUBEL 4 LADEN MET 2 WASTAFEL MAT

**NEW 779 122 205 AAA BBB\***

Frontal mate / Matte front part / Façade mat / Frontalino satinato / Frontal mate / Schubladenfront matt / Mat voorzijde

Frontal brillo / Glossy front part / Façade brillant / Frontalino lucido / Frontal brilho / Schubladenfront glänzend / Glanzend voorzijde

\* ESTE MUEBLE EXISTE, BAJO PEDIDO, SIN AGUJERO PARA GRIFERIA.  
 THIS WASHBASIN CAN BE CUSTOM ORDERED WITHOUT A TAP HOLE.  
 CE MUEBLE EXISTE, SUR COMMANDE, SANS PERÇAGE DE ROBINETTERIE.  
 QUESTO MOBILETTO È DISPONIBILE SENZA FORO PER RUBINETTERIA, SOLO SU PRENOTAZIONE.  
 ESTE MÓVEL EXISTE, SEGUNDO O PEDIDO, SEM FURO PARA TORNEIRA.  
 OHNE HAHNLOCH NUR MÖGLICH UNTER SONDERBESTELLUNG.  
 DIT MEUBEL BESTAAT, OP AANVRAAG, ZONDER KRAANGAT.

# block

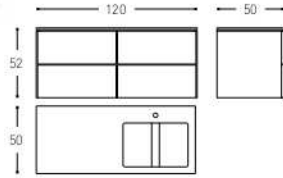

INCH 47.24x19.69x20.47

- MUEBLE 4 CAJONES CON LAVABO MATE SENO DERECHA  
4 DRAWER CABINET WITH RIGHT MATTE WASHBASIN SINK  
MEUBLE 4 TIROIRS AVEC LAVABO MAT VASQUE DROITE  
MOBILETTO 4 CASSETTI CON LAVABO OPACO SENO DESTRO  
MÓVEL DE 4 GAVETAS COM LAVATÓRIO MATE PIA DEREITA  
SCHRANK 4 SCHUBLADEN WASCHBECKEN RECHTS MATT  
MEUBEL 4 LADEN MET WASTAFEL MAT RECHTS

**NEW 779 122 215 AAA BBB\***

Frontal mate / Matte front part / Façade mat / Frontalino satinato /  
Frontal mate / Schubladenfront matt / Mat voorzijde

Frontal brillo / Glossy front part / Façade brillant / Frontalino lucido /  
Frontal brilho / Schubladenfront glänzend / Glanzend voorzijde

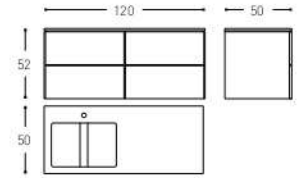

INCH 47.24x19.69x20.47

- MUEBLE 4 CAJONES CON LAVABO MATE SENO IZQUIERDA  
4 DRAWER CABINET WITH LEFT MATTE WASHBASIN SINK  
MEUBLE 4 TIROIRS AVEC LAVABO MAT VASQUE GAUCHE  
MOBILETTO 4 CASSETTI CON LAVABO OPACO SENO SINISTRO  
MÓVEL DE 4 GAVETAS COM LAVATÓRIO MATE PIA ESQUERDA  
SCHRANK 4 SCHUBLADEN WASCHBECKEN LINKS MATT  
MEUBEL 4 LADEN MET WASTAFEL MAT LINKS

**NEW 779 122 225 AAA BBB\***

Frontal mate / Matte front part / Façade mat / Frontalino satinato /  
Frontal mate / Schubladenfront matt / Mat voorzijde

Frontal brillo / Glossy front part / Façade brillant / Frontalino lucido /  
Frontal brilho / Schubladenfront glänzend / Glanzend voorzijde

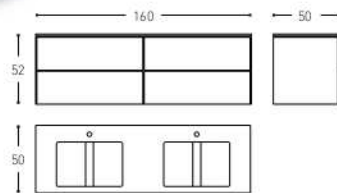

INCH 62.99x19.69x20.47

- MUEBLE 4 CAJONES CON LAVABO MATE 2 SENOS  
4 DRAWER CABINET WITH 2 SINK MATTE WASHBASIN  
MEUBLE 4 TIROIRS AVEC LAVABO MAT 2 VASQUES  
MOBILETTO 4 CASSETTI CON LAVABO OPACO 2 SENI  
MÓVEL DE 4 GAVETAS COM LAVATÓRIO MATE 2 PIAS  
SCHRANK 4 SCHUBLADEN 2 WASCHBECKEN MATT  
MEUBEL 4 LADEN MET 2 WASTAFEL MAT

**NEW 779 123 005 AAA BBB\***

Frontal mate / Matte front part / Façade mat / Frontalino satinato /  
Frontal mate / Schubladenfront matt / Mat voorzijde

Frontal brillo / Glossy front part / Façade brillant / Frontalino lucido /  
Frontal brilho / Schubladenfront glänzend / Glanzend voorzijde

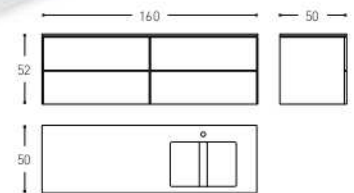

INCH 62.99x19.69x20.47

- MUEBLE 4 CAJONES CON LAVABO MATE SENO DERECHA  
4 DRAWER CABINET WITH RIGHT MATTE WASHBASIN SINK  
MEUBLE 4 TIROIRS AVEC LAVABO MAT VASQUE DROITE  
MOBILETTO 4 CASSETTI CON LAVABO OPACO SENO DESTRO  
MÓVEL DE 4 GAVETAS COM LAVATÓRIO MATE PIA DEREITA  
SCHRANK 4 SCHUBLADEN WASCHBECKEN RECHTS MATT  
MEUBEL 4 LADEN MET WASTAFEL MAT RECHTS

**NEW 779 123 015 AAA BBB\***

Frontal mate / Matte front part / Façade mat / Frontalino satinato /  
Frontal mate / Schubladenfront matt / Mat voorzijde

Frontal brillo / Glossy front part / Façade brillant / Frontalino lucido /  
Frontal brilho / Schubladenfront glänzend / Glanzend voorzijde



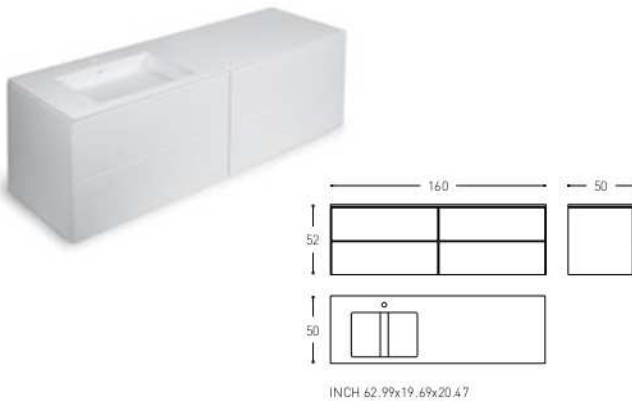

- MUEBLE 4 CAJONES CON LAVABO MATE SENO IZQUIERDA  
4 DRAWER CABINET WITH LEFT MATTE WASHBASIN SINK  
MEUBLE 4 TIROIRS AVEC LAVABO MAT VASQUE GAUCHE  
MOBILETTO 4 CASSETTI CON LAVABO OPACO SENO SINISTRO  
MÓVEL DE 4 GAVETAS COM LAVATÓRIO MATE PIA ESQUERDA  
SCHRANK 4 SCHUBLADEN WASHBECKEN LINKS MATT  
MEUBEL 4 LADEN MET WASTAFEL MAT LINKS

**NEW 779 123 025 AAA BBB\***

Frontal mate / Matte front part / Façade mat / Frontalino satinato /  
Frontal mate / Schubladenfront matt / Mat voorzijde

Frontal brillo / Glossy front part / Façade brillant / Frontalino lucido /  
Frontal brilho / Schubladenfront glänzend / Glanzend voorzijde

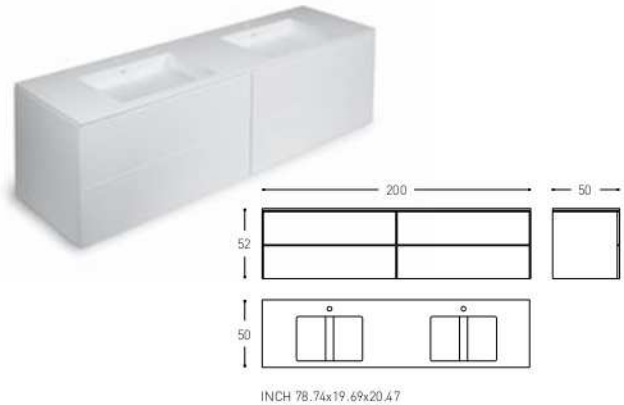

- MUEBLE 4 CAJONES CON LAVABO MATE 2 SENOS  
4 DRAWER CABINET WITH 2 SINK MATTE WASHBASIN  
MEUBLE 4 TIROIRS AVEC LAVABO MAT 2 VASQUES  
MOBILETTO 4 CASSETTI CON LAVABO OPACO 2 SENI  
MÓVEL DE 4 GAVETAS COM LAVATÓRIO MATE 2 PIAS  
SCHRANK 4 SCHUBLADEN 2 WASHBECKEN MATT  
MEUBEL 4 LADEN MET 2 WASTAFEL MAT

**NEW 779 123 805 AAA BBB\***

Frontal mate / Matte front part / Façade mat / Frontalino satinato /  
Frontal mate / Schubladenfront matt / Mat voorzijde

Frontal brillo / Glossy front part / Façade brillant / Frontalino lucido /  
Frontal brilho / Schubladenfront glänzend / Glanzend voorzijde

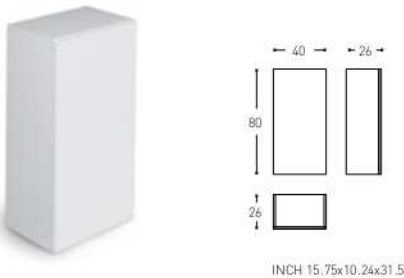

- ARMARIO  
CABINET  
ARMOIRE  
ARMADIETTO  
ARMÁRIO  
SCHRANK  
KAST

**779 001 407 AAA BBB**

Frontal mate / Matte front part / Façade mat / Frontalino satinato /  
Frontal mate / Schubladenfront matt / Mat voorzijde

Frontal brillo / Glossy front part / Façade brillant / Frontalino lucido /  
Frontal brilho / Schubladenfront glänzend / Glanzend voorzijde

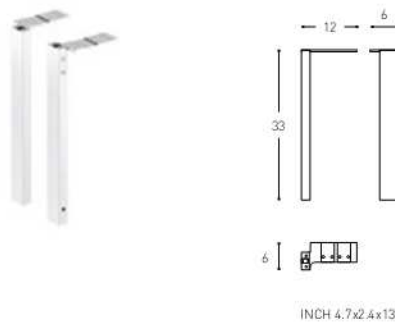

- CONJUNTO PIES  
LEGS SET  
PIEDS DE MEUBLE  
PIEDI DI MOBILE  
CONJUNTO DE PÉS  
SCHRANKFÜSSE  
SET POTEN

**719 01 99**

Cromo brillo / Glossy chrome / Chromé brillant / Cromo lucido /  
Cromo brilho / Chrom glänzend / Glanzend verchromd

\* ESTE MUEBLE EXISTE, BAJO PEDIDO, SIN AGUJERO PARA GRIFERIA.  
THIS WASHBASIN CAN BE CUSTOM ORDERED WITHOUT A TAP HOLE.  
CE MEUBLE EXISTE, SUR COMMANDE, SANS PERÇAGE DE ROBINETTERIE.  
QUESTO MOBILETTO È DISPONIBILE SENZA FORO PER RUBINETTERIA, SOLO SU PRENOTAZIONE.  
ESTE MÓVEL EXISTE, SEGUNDO O PEDIDO, SEM FURO PARA TORNEIRA.  
OHNE HAHNLOCH NUR MÖGLICH UNTER SONDERBESTELLUNG.  
DIT MEUBEL BESTAAT, OP AANVRAAG, ZONDER KRAANGAT.



# block

recambios spare parts pièces detachées ricambi peças de reposição ersatzteile reserveonderdelen

**SIFÓN CON VÁLVULA PREVEX / TRAP WITH VALVE PREVEX / SIPHON AVEC VIDAGE PREVEX / SIFONE CON VALVOLA PREVEX / SIFÃO COM VÁLVULA PREVEX / ABLAUGGARNITUR MIT ABLAUFVENTIL PREVEX / AFVOERBUIJS MET AFSLUITER PREVEX**

341 91 51

RECAMBIO DE / SPARE PART OF / PIÈCES DETACHÉES DE / RICAMBIO DI / PEÇA DE REPOSIÇÃO DE / ERSATZTEIL FÜR / ONDERDEEL VAN  
779123005AAAABBB, 779123015AAAABBB, 779123025AAAABBB, 779123055AAAABBB, 779123065AAAABBB, 779123075AAAABBB, 779123805AAAABBB, 779123855AAAABBB

**TAPA DESAGÜE / DRAIN COVER / PLAQUE BONDE / TAPPO PILETTA / TAMPÁ DESCARGA / ABLAUFDECKEL / KLEP AFVOERLEIDING**

341 02 97 30 x 8,6 CM / INCH 11.8 x 3.4

**KIT LIMPIEZA BIOBASED / BIOBASED CLEANING SET / KIT DE NETTOYAGE BIOBASED / KIT DI PULIZIA BIOBASED / KIT DE LIMPEZA BIOBASED / REINIGINGSSET BIOBASED / REINIGINGSSET BIOBASED**

341 02 95

**KIT REPARACIÓN BIOBASED / BIOBASED REPAIRING KIT / KIT RÉPARATION BIOBASED / KIT RIPARAZIONE BIOBASED / KIT REPARAÇÃO BIOBASED / REPARATURKIT BIOBASED / BIOBASED REPARATIE SET**

341 02 96

**ACCESORIO SUJECIÓN MUEBLE / CABINET WITH WASHBASIN WALL MOUNTING SET / KIT FIXATION MURALE MEUBLE / ACCESSORIO FISSAGGIO MURO MOBILETTO / CONJUNTO FIXAÇÃO MÓVEL / WANDFIXIERUNGSSET MOBILIAR / MONTAGESET KRAAN**

341 91 20 60 CM / INCH 23.6

RECAMBIO DE / SPARE PART OF / PIÈCES DETACHÉES DE / RICAMBIO DI / PEÇA DE REPOSIÇÃO DE / ERSATZTEIL FÜR / ONDERDEEL VAN  
779001003AAAABBB, 779001013AAAABBB, 779121003AAAABBB, 779121053AAAABBB, 779122215AAAABBB, 779122225AAAABBB, 779122255AAAABBB, 779122265AAAABBB, 779122275AAAABBB

341 91 21 80 CM / INCH 31.5

RECAMBIO DE / SPARE PART OF / PIÈCES DETACHÉES DE / RICAMBIO DI / PEÇA DE REPOSIÇÃO DE / ERSATZTEIL FÜR / ONDERDEEL VAN  
779001403AAAABBB, 779001413AAAABBB, 779121403AAAABBB, 779121453AAAABBB, 779123005AAAABBB, 779123015AAAABBB, 779123025AAAABBB, 779123055AAAABBB, 779123065AAAABBB, 779123075AAAABBB

341 91 22 100 CM / INCH 39.4

RECAMBIO DE / SPARE PART OF / PIÈCES DETACHÉES DE / RICAMBIO DI / PEÇA DE REPOSIÇÃO DE / ERSATZTEIL FÜR / ONDERDEEL VAN  
779001803AAAABBB, 779121803AAAABBB, 779121853AAAABBB, 779123805AAAABBB, 779123855AAAABBB

**CAJÓN SUPERIOR / UPPER DRAWER / TIROIR SUPÉRIEUR / CASSETTO SUPERIORE / GAVETA SUPERIOR / OBERE SCHUBLADE / BOVENLADE**

341 02 84 60 CM / INCH 23.6

RECAMBIO DE / SPARE PART OF / PIÈCES DETACHÉES DE / RICAMBIO DI / PEÇA DE REPOSIÇÃO DE / ERSATZTEIL FÜR / ONDERDEEL VAN  
779001003AAAABBB, 779121003AAAABBB, 779121053AAAABBB, 779122205AAAABBB, 779122215AAAABBB, 779122225AAAABBB, 779122255AAAABBB, 779122265AAAABBB, 779122275AAAABBB

341 02 85 80 CM / INCH 31.5

RECAMBIO DE / SPARE PART OF / PIÈCES DETACHÉES DE / RICAMBIO DI / PEÇA DE REPOSIÇÃO DE / ERSATZTEIL FÜR / ONDERDEEL VAN  
779001403AAAABBB, 779121403AAAABBB, 779121453AAAABBB, 779123005AAAABBB, 779123015AAAABBB, 779123025AAAABBB, 779123055AAAABBB, 779123065AAAABBB, 779123075AAAABBB

341 02 86 100 CM / INCH 39.4

RECAMBIO DE / SPARE PART OF / PIÈCES DETACHÉES DE / RICAMBIO DI / PEÇA DE REPOSIÇÃO DE / ERSATZTEIL FÜR / ONDERDEEL VAN  
779001803AAAABBB, 779121803AAAABBB, 779123805AAAABBB, 779123855AAAABBB

**CAJÓN SUPERIOR MUEBLE SIN ENCIMERA / UPPER DRAWER FOR CABINET WITHOUT TOP / TIROIR SUPÉRIEUR MEUBLE SANS PLAN / CASSETTO SUPERIORE MOBILE SENZA PIANO CON LAVABO INTEGRATO / GAVETA SUPERIOR PARA MÓVEL SEM TAMPO / OBERE SCHUBLADE FÜR SCHRANK OHNE AUFLAGE / BOVENLADE VOOR MEUBEL ZONDER BOVENBLAD**

341 01 36 60 CM / INCH 23.6

RECAMBIO DE / SPARE PART OF / PIÈCES DETACHÉES DE / RICAMBIO DI / PEÇA DE REPOSIÇÃO DE / ERSATZTEIL FÜR / ONDERDEEL VAN  
779001013AAAABBB, 779122215AAAABBB, 779122225AAAABBB, 779122265AAAABBB, 779122275AAAABBB

341 02 48 80 CM / INCH 31.5

RECAMBIO DE / SPARE PART OF / PIÈCES DETACHÉES DE / RICAMBIO DI / PEÇA DE REPOSIÇÃO DE / ERSATZTEIL FÜR / ONDERDEEL VAN  
779001413AAAABBB, 779123015AAAABBB, 779123025AAAABBB, 779123065AAAABBB, 779123075AAAABBB

**CAJÓN INFERIOR / LOWER DRAWER / TIROIR INFÉRIEUR / CASSETTO INFERIORE / GAVETA INFERIOR / UNTERE SCHUBLADE / ONDERLADE**

341 01 31 60 CM / INCH 23.6

RECAMBIO DE / SPARE PART OF / PIÈCES DETACHÉES DE / RICAMBIO DI / PEÇA DE REPOSIÇÃO DE / ERSATZTEIL FÜR / ONDERDEEL VAN  
779001003AAAABBB, 779121003AAAABBB, 779121053AAAABBB, 779122205AAAABBB, 779122215AAAABBB, 779122225AAAABBB, 779122255AAAABBB, 779122265AAAABBB, 779122275AAAABBB

341 01 33 80 CM / INCH 31.5

RECAMBIO DE / SPARE PART OF / PIÈCES DETACHÉES DE / RICAMBIO DI / PEÇA DE REPOSIÇÃO DE / ERSATZTEIL FÜR / ONDERDEEL VAN  
779001403AAAABBB, 779121403AAAABBB, 779121453AAAABBB, 779123005AAAABBB, 779123015AAAABBB, 779123025AAAABBB, 779123055AAAABBB, 779123065AAAABBB, 779123075AAAABBB

341 01 35 100 CM / INCH 39.4

RECAMBIO DE / SPARE PART OF / PIÈCES DETACHÉES DE / RICAMBIO DI / PEÇA DE REPOSIÇÃO DE / ERSATZTEIL FÜR / ONDERDEEL VAN  
779001803AAAABBB, 779121803AAAABBB, 779121853AAAABBB, 779123805AAAABBB, 779123855AAAABBB

**CAJÓN INFERIOR MUEBLE SIN ENCIMERA / LOWER DRAWER FOR CABINET WITHOUT TOP / TIROIR INFÉRIEUR MEUBLE SANS PLAN / CASSETTO INFERIORE MOBILE SENZA PIANO / GAVETA INFERIOR PARA MÓVEL SEM TAMPO / UNTERE SCHUBLADE FÜR SCHRANK OHNE AUFLAGE / ONDERLADE VOOR MEUBEL ZONDER WERKBLAD**

341 01 37 60 CM / INCH 23.6

RECAMBIO DE / SPARE PART OF / PIÈCES DETACHÉES DE / RICAMBIO DI / PEÇA DE REPOSIÇÃO DE / ERSATZTEIL FÜR / ONDERDEEL VAN  
779001013AAAABBB, 779122215AAAABBB, 779122225AAAABBB, 779122265AAAABBB, 779122275AAAABBB

341 02 49 80 CM / INCH 31.5

RECAMBIO DE / SPARE PART OF / PIÈCES DETACHÉES DE / RICAMBIO DI / PEÇA DE REPOSIÇÃO DE / ERSATZTEIL FÜR / ONDERDEEL VAN  
779001413AAAABBB, 779123015AAAABBB, 779123025AAAABBB, 779123065AAAABBB, 779123075AAAABBB

**JUEGO DE GUÍAS MUEBLE LAVABO / RAIL SYSTEM SET FOR CABINET WITH BASIN / SET GLISSIÈRES MEUBLE LAVABO / SET GUIDE MOBILE LAVABO / JOGO DE GUÍAS PARA MÓVEL LAVATÓRIO / SCHIENE NSET FÜR UNTERSCHRANK / LADEGELEIDERS VOOR MEUBEL**

341 01 38 {60-80-100 CM / INCH 23.6-31.5-39.4}

RECAMBIO DE / SPARE PART OF / PIÈCES DETACHÉES DE / RICAMBIO DI / PEÇA DE REPOSIÇÃO DE / ERSATZTEIL FÜR / ONDERDEEL VAN  
779001003AAAABBB, 779001403AAAABBB, 779001803AAAABBB, 779121003AAAABBB, 779121053AAAABBB, 779121403AAAABBB, 779121453AAAABBB, 779121803AAAABBB, 779121853AAAABBB, 779122205AAAABBB, 779122215AAAABBB, 779122225AAAABBB, 779122255AAAABBB, 779122265AAAABBB, 779122275AAAABBB, 779123005AAAABBB, 779123015AAAABBB, 779123025AAAABBB, 779123055AAAABBB, 779123065AAAABBB, 779123075AAAABBB, 779123805AAAABBB, 779123855AAAABBB



**JUEGO DE GUÍAS MUEBLE + MUEBLE SIN ENCIMERA / RAIL SYSTEM SET + CABINET WITHOUT TOP / SET GLISSIÈRES MEUBLE + MEUBLE SANS PLAN / SET GUIDE MOBILE + MOBILE SENZA LAVABO INTEGRATO / JOGO DE GUIAS PARA MÓVEL + MÓVEL SEM TAMPO / SCHIENENSSET FÜR SCHRANK + SCHRANK MIT AUFLAGE / LADEGELEIDERS VOOR MEUBEL + MEUBEL ZONDER WERKBLAD**

341 01 39 (60-80 CM / INCH 23.6-31.5)

RECAMBIO DE / SPARE PART OF / PIÈCES DETACHÉES DE / RICAMBIO DI / PEÇA DE REPOSIÇÃO DE / ERSATZTEIL FÜR / ONDERDEEL VAN  
779001013AAABBB, 779001413AAA BBB, 779122215AAA BBB, 779122225AAA BBB, 779122265AAA BBB, 779122275AAA BBB, 779123015AAA BBB, 779123025AAA BBB, 779123065AAA BBB, 779123075AAA BBB

**FRONTALES (2) / FRONT PARTS (2) / FAÇADES (2) / FRONTALINI (2) / FRONTAIS (2) / SCHUBLADENFRONTS (2) / VOORZIJDE (2)**

**MATE / MATTE / MAT / SATINATO / MATE / MATT / MAT**

779 990 01 BBB 60 CM / INCH 23.6  
779 990 02 BBB 80 CM / INCH 31.5  
779 990 03 BBB 100 CM / INCH 39.4

**BRILLO / GLOSSY / BRILLANT / LUCIDO / BRILHO / GLÄNZEND / GLANZEND**

779 990 01 BBB 60 CM / INCH 23.6  
779 990 02 BBB 80 CM / INCH 31.5  
779 990 03 BBB 100 CM / INCH 39.4

**SEPARADOR RECTO / STRAIGHT DIVIDER / SÉPARATEUR DROIT / SEPARATORE RECTO / SEPARADOR RECTO / SCHUBLADENAUFTEILER GERADE / RECHTE VERDELER**

341 90 11 35 CM / INCH 13.8

RECAMBIO DE / SPARE PART OF / PIÈCES DETACHÉES DE / RICAMBIO DI / PEÇA DE REPOSIÇÃO DE / ERSATZTEIL FÜR / ONDERDEEL VAN  
779001003AAABBB, 779001403AAA BBB, 779001803AAA BBB, 779121003AAA BBB, 779121053AAA BBB, 779121403AAA BBB, 779121803AAA BBB, 779122205AAA BBB, 779122215AAA BBB, 779122225AAA BBB, 779122255AAA BBB, 779122265AAA BBB, 779122275AAA BBB, 779123005AAA BBB, 779123015AAA BBB, 779123025AAA BBB, 779123055AAA BBB, 779123065AAA BBB, 779123075AAA BBB, 779123805AAA BBB, 779123855AAA BBB

**SEPARADOR CURVO / RIGHT ANGLE DIVIDER / SÉPARATEUR A ANGLES / SEPARATORE AD ANGOLI / SEPARADOR CURVO / SCHUBLADENAUFTEILER ECKIG / RECHTHOEK VERDELER**

341 90 14 35 CM / INCH 13.8

RECAMBIO DE / SPARE PART OF / PIÈCES DETACHÉES DE / RICAMBIO DI / PEÇA DE REPOSIÇÃO DE / ERSATZTEIL FÜR / ONDERDEEL VAN  
779001003AAABBB, 779001403AAA BBB, 779001803AAA BBB, 779121003AAA BBB, 779121053AAA BBB, 779121403AAA BBB, 779121453AAA BBB, 779121803AAA BBB, 779121853AAA BBB, 779122205AAA BBB, 779122215AAA BBB, 779122225AAA BBB, 779122255AAA BBB, 779122265AAA BBB, 779122275AAA BBB, 779123005AAA BBB, 779123015AAA BBB, 779123025AAA BBB, 779123055AAA BBB, 779123065AAA BBB, 779123075AAA BBB, 779123805AAA BBB, 779123855AAA BBB

**CONTAINER / CONTAINER / PORTE-OBJETS / PORTA-OGGETTI / PORTA-OBJECTOS / BEHÄLTER / VOORWERPEN HOUDER**

341 90 15 20x10x7 CM / INCH 7.9x3.9x2.7

RECAMBIO DE / SPARE PART OF / PIÈCES DETACHÉES DE / RICAMBIO DI / PEÇA DE REPOSIÇÃO DE / ERSATZTEIL FÜR / ONDERDEEL VAN  
779001003AAABBB, 779001403AAA BBB, 779001803AAA BBB, 779121003AAA BBB, 779121053AAA BBB, 779121403AAA BBB, 779121453AAA BBB, 779121803AAA BBB, 779122205AAA BBB, 779122215AAA BBB, 779122225AAA BBB, 779122255AAA BBB, 779122265AAA BBB, 779122275AAA BBB, 779123005AAA BBB, 779123015AAA BBB, 779123025AAA BBB, 779123055AAA BBB, 779123065AAA BBB, 779123075AAA BBB, 779123805AAA BBB, 779123855AAA BBB

**ACCESORIO SUJECIÓN ARMARIO / CABINET MOUNTING SET / KIT FIXATION ARMOIRE / ACCESSORIO FISSAGGIO ARMADIO / CONJUNTO FIXAÇÃO ARMÁRIO / SCHRANKFIXIERUNGSET / MONTAGESET KAST**

341 91 19

RECAMBIO DE / SPARE PART OF / PIÈCES DETACHÉES DE / RICAMBIO DI / PEÇA DE REPOSIÇÃO DE / ERSATZTEIL FÜR / ONDERDEEL VAN  
779001407AAABBB

**BISAGRAS ARMARIO / HINGE CABINET / CHARNIÈRES ARMOIRE / CERNIERE ARMADIETTO / DOBRADIÇAS ARMÁRIO / TÜRSCHARNIERE SCHRANK / SCHARNIER KAST**

341 91 01

RECAMBIO DE / SPARE PART OF / PIÈCES DETACHÉES DE / RICAMBIO DI / PEÇA DE REPOSIÇÃO DE / ERSATZTEIL FÜR / ONDERDEEL VAN  
779001407AAABBB

**PUERTA ARMARIO / CABINET DOOR / PORTE ARMOIRE / PORTA ARMADIO / PORTA ARMÁRIO / TÜR SCHRANK / DEUR KAST**

**MATE / MATTE / MAT / SATINATO / MATE / MATT / MAT**

779 990 04 BBB

**BRILLO / GLOSSY / BRILLANT / LUCIDO / BRILHO / GLÄNZEND / GLANZEND**

779 990 04 BBB





Block evo es el **equilibrio** perfecto entre **diseño** y precio. Ofrece todo aquello que esperas: diseño **icónico**, máxima **funcionalidad** y fácil mantenimiento. Esto es Block Evo, la **nueva** versión de Block accesible a **todos**

*Block Evo is the perfect **balance** between **design** and price. It offers what you expect: **iconic** design, maximal **functionality** and easy maintenance. This is Block Evo, the **new** version of Block, open to **all***

# block evo

DESIGN BY COSMIC STUDIO





**719001407139139**  
ARMARIO  
CABINET  
(35x20x77,5)

**719011803139139**  
MUEBLE 2 CAJONES LAVABO TECKSTONE BRILLO  
2 DRAWER CABINET & GLOSSY TECKSTONE WASHBASIN  
(100,5x50x58)

**719002808139139**  
ARMARIO  
CABINET  
(35x20x155)









**719011803139139**  
MUEBLE 2 CAJONES LAVABO TECKSTONE BRILLO  
2 DRAWER CABINET & GLOSSY TECKSTONE WASHBASIN  
(100,5x50x58)

**719001407139139**  
ARMARIO  
CABINET  
(35x20x77,5)





**719021803034034**  
MUEBLE 2 CAJONES LAVABO TECKSTONE MATE  
2 DRAWER CABINET & MATTE TECKSTONE WASHBASIN  
(100,5x50x58)

**719002808034034**  
ARMARIO  
CABINET  
(35x20x155)



**719021803034034**

MUEBLE 2 CAJONES LAVABO TECKSTONE MATE  
2 DRAWER CABINET & MATTE TECKSTONE WASHBASIN  
(100,5x50x58)

**719002808034034**

ARMARIO  
CABINET  
(35x20x155)